

TrustLink Metal Shell Connectors

Rugged reliability – excellent performance



Built with advanced technology, robust materials, and MacArtney connectivity expertise, the TrustLink MS series is made of stainless steel and comes in three shell sizes that are compatible with industry standards. These high-density connectors are suitable for the harshest marine environments due to their rugged durability and reliability, and the compact modular design is advantageous where limited space is a factor.

The TrustLink MS range is available in several configurations from 4 to 37 electrical contacts and a Hybrid with 2FO and 4E contacts, offering excellent flexibility to subsea equipment and system operators.

Manufactured as standard in stainless steel, the TrustLink connector has a life expectancy of 25 years with cathodic protection and regular maintenance. Titanium is also an available option, offering a life expectancy of 25 years in subsea environments with no additional protection.

All electrical connectors and bulkheads can be supplied unterminated and are available globally from MacArtney entities.

Reversed male/female inserts

The TrustLink series allows mounting of either a male or a female insert in the same housing, making it a very versatile connector.

Highlighted specifications

- Depth rating 600 bar/8,700 psi
- Available in 3 standard shell sizes
- Up to 25 A rating
- Designed and tested to the EN 60664-1 and EN 50393-Table 5 standard

Features and benefits

- Available globally from MacArtney entities
- CCP connectors are available in overmould and boot versions
- Interchangeable and reversible male/female inserts
- Compact modular design
- Anti-seizing surface
- Available in multiple configurations

Applications

- ROV/AUV/trenchers
- Naval systems and equipment
- Oceanographic systems, equipment and instrumentation solutions
- Seismic/ocean bottom systems
- Subsea nodes
- Underwater camera, video and lighting
- Survey systems and instrumentation
- Offshore oil and gas systems
- Subsea renewable systems
- Power supply for underwater pumps
- Underwater telemetry systems
- Dredging
- Harsh environment monitoring systems

Options

- Can be supplied with moulding and termination
- Water blocked in case of cable damage*
- Available for pressure balanced systems*
- Back pressure rated to 600 bar*
- Other materials are available on request

*only on electrical 4-37 contact

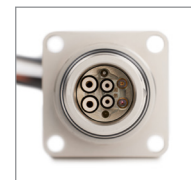

Specifications - size A

Electrical

	4 contacts	8 contacts	12 contacts
Contact size:	14 AWG	18 AWG	20 AWG
Contact size:	2.1 mm ²	0.8 mm ²	0.5 mm ²
Voltage rating:	600 VAC/VDC	600 VAC/VDC	250 VAC/VDC
Dielectric withstand:	4,000 VAC	4,000 VAC	2,500 VAC
Current rating			
Up to 4 contacts loaded:	25 A	12 A	12 A
Current rating			
Up to 10 contacts loaded:		8 A	7 A
Current rating			
All contacts loaded:	25 A	8 A	7 A

Materials

Metal shell housing:	Diamond polished AISI 316* Diamond polished Titanium G II
Locking sleeves:	Diamond polished Nickel Aluminium Bronze C63000* Diamond polished Titanium G II
Pressure cap:	Diamond polished AISI 316* Diamond polished Titanium G II
Dust cap:	POM
Electrical insert:	Glass reinforced high performance thermoplastic
O-ring:	FPM-75

Environmental

Qualified pressure tested:	Mated 720 bar/10,400 psi
Depth rating:	Mated 600 bar/8,700 psi
Temperature rating:	
Water:	-4 to 70°C/25 to 158°F
Air:	-25 to 70°C/13 to 158°F
Storage:	-25 to 70°C/13 to 158°F

Standards

Creepage distances and clearance:	EN 60664-1, tables F2 and F4
Electrical low voltage tests:	EN 50393, table 5

*Other materials on request

Face view (male)

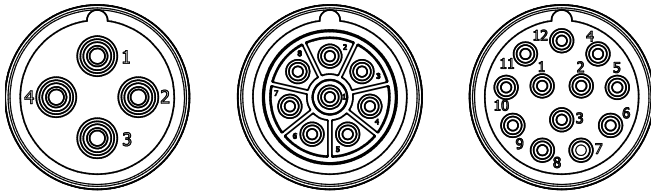

Mounting hole for BCR SA

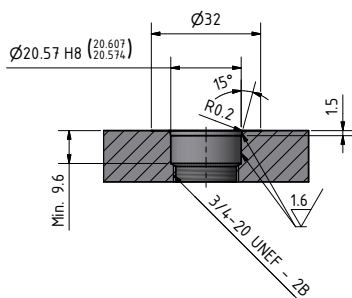

Mounting hole for FCR SA

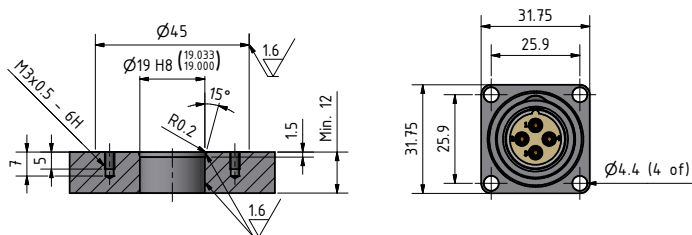

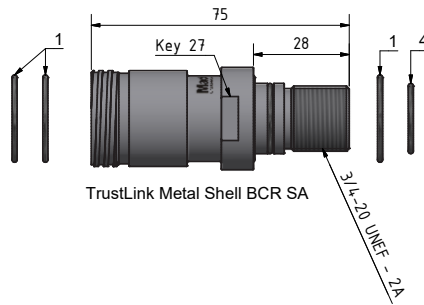
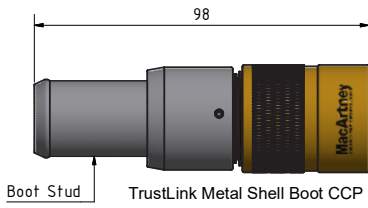
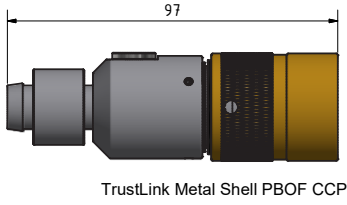
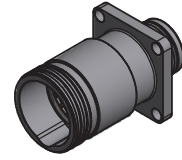
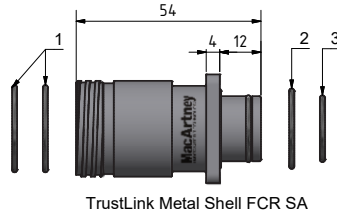
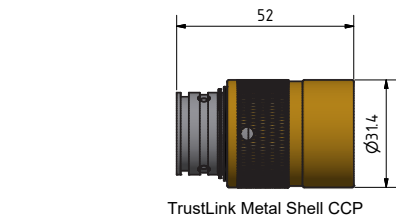

Boot A-B size for cable $\varnothing 7.5\text{-}\varnothing 9.5$
 Boot A-B size for cable $\varnothing 9.5\text{-}\varnothing 12$
 Boot A-B size for cable $\varnothing 12\text{-}\varnothing 15$

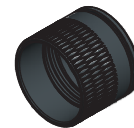
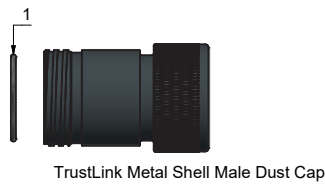
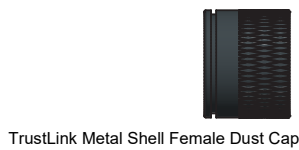
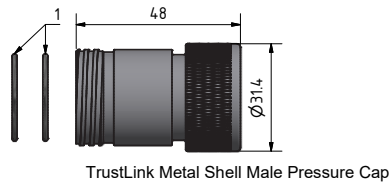
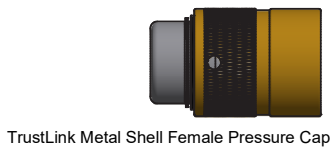
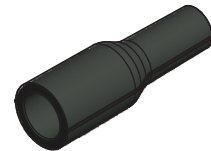

O-rings:

1. $\varnothing 22.5 \times 1.5$ FPM-75
2. $\varnothing 20.5 \times 1.5$ FPM-75
3. $\varnothing 16.5 \times 1.5$ FPM-75
4. $\varnothing 17.5 \times 1.5$ FPM-75

All measurements in millimetres (mm)

For technical information
and instructions
Scan QR code



Specifications - size B

Electrical

	16 contacts		19 contacts
Contact size:	2 x 16 AWG	14 x 20 AWG	20 AWG
Contact size:	1.3 mm ²	0.5 mm ²	0.5 mm ²
Voltage rating:	600 VAC/VDC	250 VAC/VDC	250 VAC/VDC
Dielectric withstand:	4,000 VAC	2,500 VAC	2,500 VAC
Current rating			
Up to 4 contacts loaded:	20 A	12 A	12 A
Current rating			
Up to 10 contacts loaded:	11 A	7 A	7 A
Current rating			
All contacts loaded:	9 A	6 A	6 A

Materials

Metal shell housing:	Diamond polished AISI 316* Diamond polished Titanium G II
Locking sleeves:	Diamond polished Nickel Aluminium Bronze C63000*
Pressure cap:	Diamond polished AISI 316* Diamond polished Titanium G II
Dust cap:	POM
Electrical insert:	Glass reinforced high performance thermoplastic
O-ring:	FPM-75

Environmental

Qualified pressure tested:	Mated 720 bar/10,400 psi
Depth rating:	Mated 600 bar/8,700 psi
Temperature rating:	
Water:	-4 to 70°C/25 to 158°F
Air:	-25 to 70°C/13 to 158°F
Storage:	-25 to 70°C/13 to 158°F

Standards

Creepage distances and clearance:	EN 60664-1, tables F2 and F4
Electrical low voltage tests:	EN 50393, table 5

*Other materials on request

Face view (male)

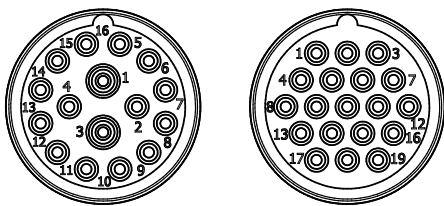

Mounting hole for BCR SB

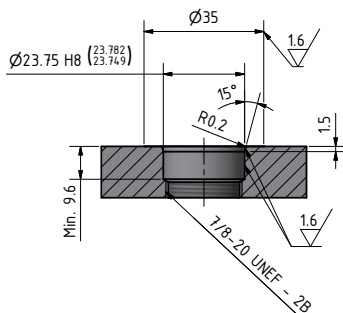

Mounting hole for FCR SB

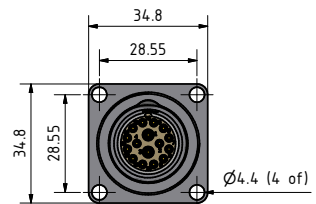
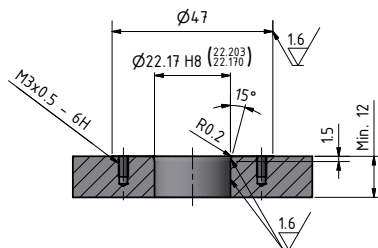

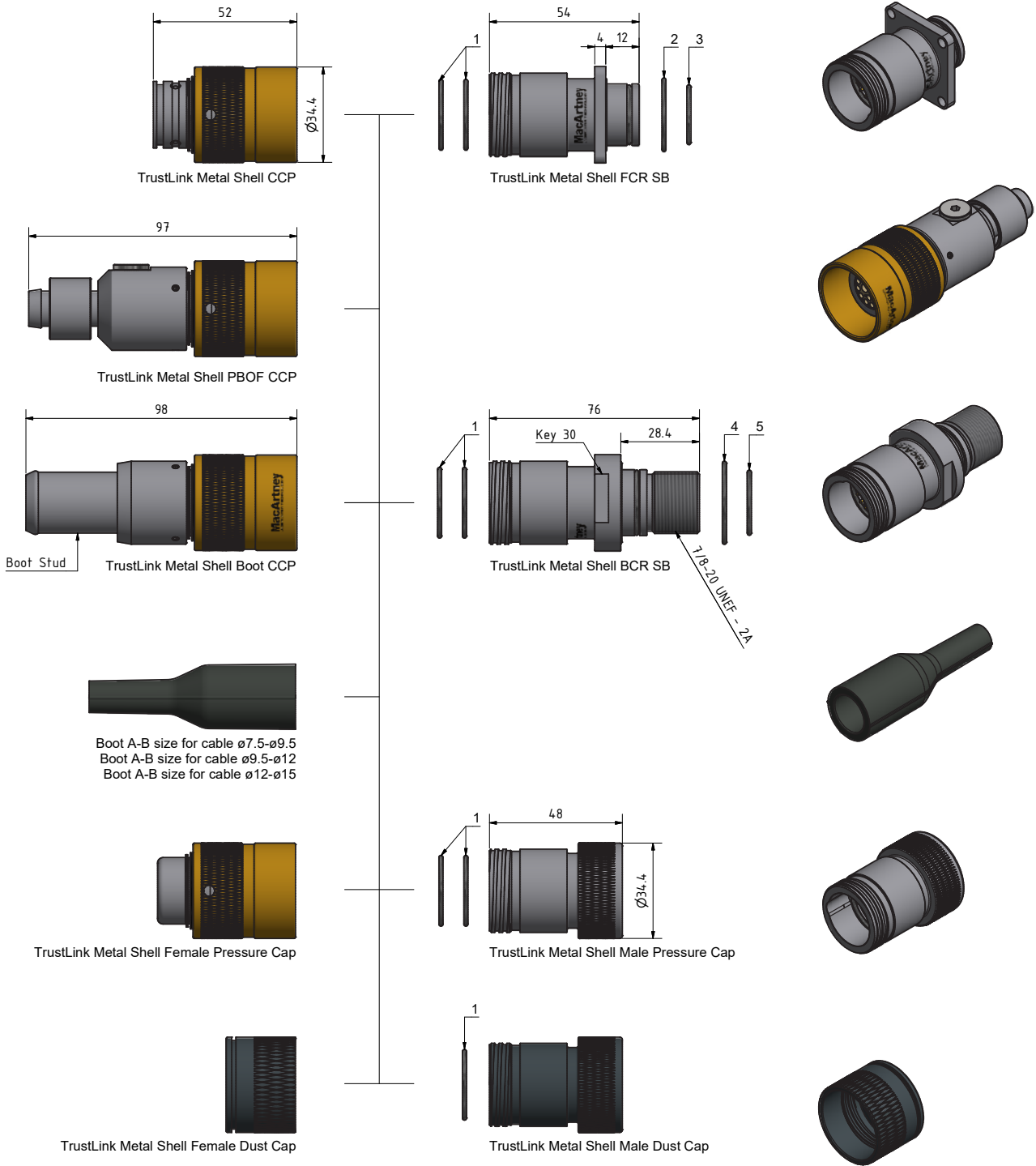

TrustLink

O-rings:

1. $\varnothing 22.5 \times 1.5$ FPM-75
2. $\varnothing 23.5 \times 1.5$ FPM-75
3. $\varnothing 18.5 \times 1.5$ FPM-75
4. $\varnothing 27.0 \times 1.5$ FPM-75
5. $\varnothing 20.5 \times 1.5$ FPM-75

All measurements in millimetres (mm)

For technical information
and instructions
Scan QR code



Specifications - size C

Electrical

	26 contacts	37 contacts
Contact size:	20 AWG	20 AWG
Contact size:	0.5 mm ²	0.5 mm ²
Voltage rating:	250 VAC/VDC	250 VAC/VDC
Dielectric withstand:	2,500 VAC	2,500 VAC
Current rating		
Up to 4 contacts loaded:	12 A	12 A
Current rating		
Up to 10 contacts loaded:	7 A	7 A
Current rating		
All contacts loaded:	5 A	5 A

Materials

Metal shell housing:	Diamond polished AISI 316*
	Diamond polished Titanium G II
Locking sleeves:	Diamond polished
	Nickel Aluminium Bronze
	C63000*
	Diamond polished Titanium G II
Pressure cap:	Diamond polished AISI 316*
	Diamond polished Titanium G II
Dust cap:	POM
Electrical insert:	Glass reinforced high performance thermoplastic
O-ring:	FPM-75

Environmental

Qualified pressure tested:	Mated 720 bar/10,400 psi
Depth rating:	Mated 600 bar/8,700 psi
Temperature rating:	
Water:	-4 to 70°C/25 to 158°F
Air:	-25 to 70°C/13 to 158°F
Storage:	-25 to 70°C/13 to 158°F

Standards

Creepage distances and clearance:	EN 60664-1, tables F2 and F4
Electrical low voltage tests:	EN 50393, table 5

*Other materials on request

Face view (male)

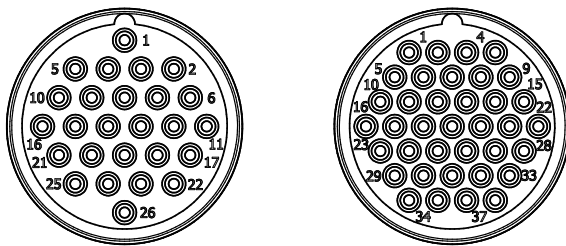

Mounting hole for BCR SC

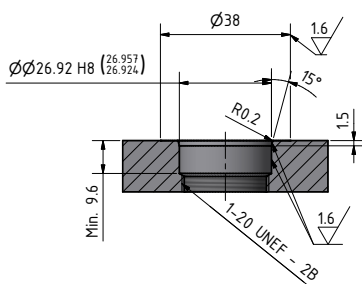

Mounting hole for FCR SC

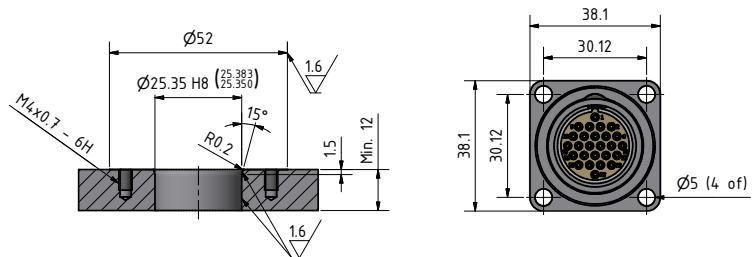

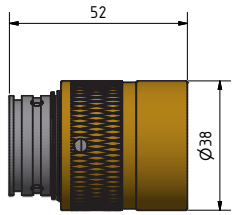

TrustLink Metal Shell CCP

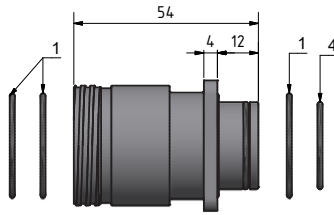

TrustLink Metal Shell FCR SC

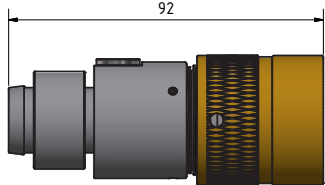
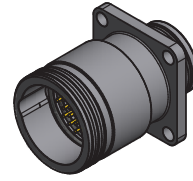

TrustLink Metal Shell PBOF CCP

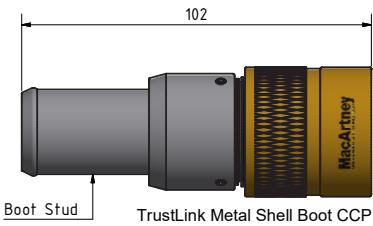

TrustLink Metal Shell Boot CCP

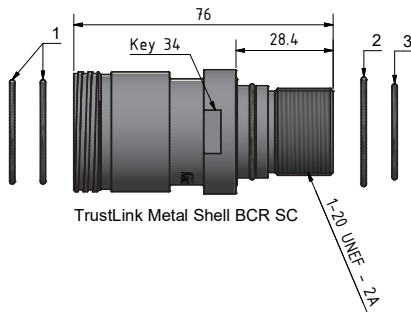

TrustLink Metal Shell BCR SC



Boot C size for cable ø8-ø10
 Boot C size for cable ø10-ø12
 Boot C size for cable ø12-ø15
 Boot C size for cable ø15-ø18

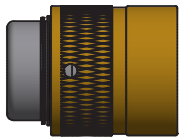
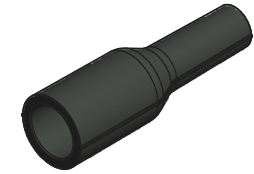

TrustLink Metal Shell Female Pressure Cap

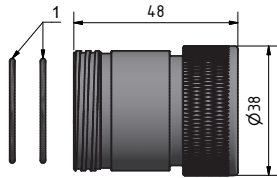

TrustLink Metal Shell Male Pressure Cap



TrustLink Metal Shell Female Dust Cap

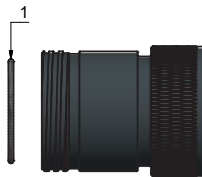

TrustLink Metal Shell Male Dust Cap

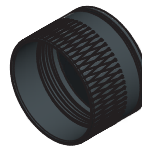

O-rings:

1. ø27.5 x 1.5 FPM-75
2. ø29.0 x 1.5 FPM-75
3. ø25.0 x 1.5 FPM-75
4. ø22.5 x 1.5 FPM-75

All measurements in millimetres (mm)

For technical information
 and instructions
Scan QR code



Specifications - hybrid

Electrical

	4 contacts
Contact size:	2 x 16 AWG
Voltage rating:	600 VAC/800 VDC
Current rating:	13 A
Contact size:	2 x 20 AWG
Voltage rating:	250 VAC/350 VDC
Current rating:	5 A
Current rating - all contacts loaded:	36 A

Materials

Metal shell housing:	Diamond polished AISI 316*
Locking sleeves:	Diamond polished Nickel Aluminium Bronze C63000*
Pressure cap:	Diamond polished AISI 316*
Dust cap:	POM
Insert:	Stainless steel
O-ring:	FPM-75

*Other materials on request

Optical (single mode)

Wavelength:	1,310 to 1,550 nm
Attenuation:	Max 2.5 dB, Typical 1.0-1.5 dB (when mated)
Fibre types:	9/125 µm
Connector back reflection:	40 dB (typical) 32 dB (max)
Optical passes:	2 passes

Optical specifications (multi mode)

Wavelength:	850 to 1,300 nm
Attenuation:	Max 2.5 dB Typical 1.0-1.5 dB (when mated)
Fibre types:	50/125 µm
Optical passes:	2 passes

Environmental

Qualified pressure tested:	Mated 720 bar/10,400 psi
Depth rating:	Mated 600 bar/8,700 psi (dry box)
Temperature rating:	
Water:	-4 to 70°C/25 to 158°F
Air:	-25 to 70°C/13 to 158°F
Storage:	-25 to 70°C/13 to 158°F

Recommended cable

Type 3644 CC or 3780 CC

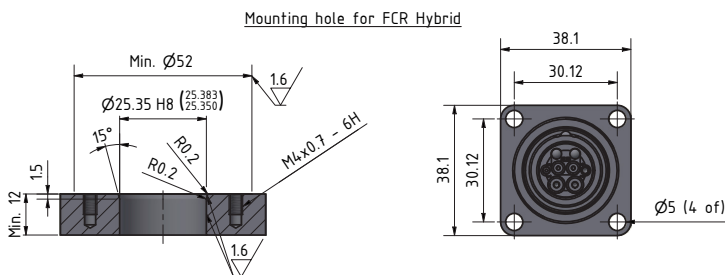
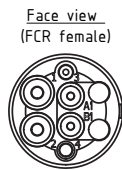
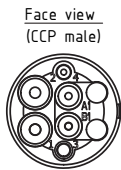

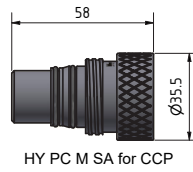
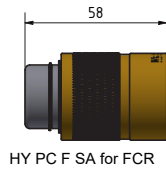
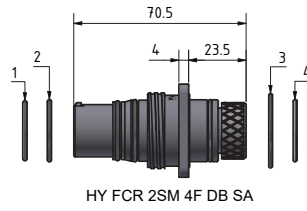
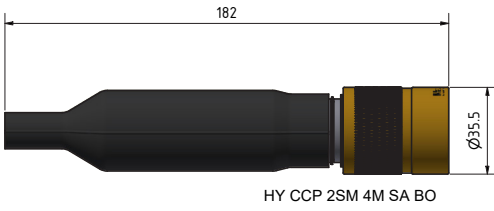

TrustLink

O-rings:

1. $\varnothing 20.35 \times 1.78$ FPM-75
2. $\varnothing 21.95 \times 1.78$ FPM-75
3. $\varnothing 27.50 \times 1.50$ FPM-75
4. $\varnothing 22.50 \times 1.50$ FPM-75

All measurements in millimetres (mm)

For technical information
and instructions
Scan QR code

