

SubConn® HF Coax

50 ohm Coax

Connector specifications

Voltage rating on coax insert only	800 V, max nominal voltage acc. to MIL									
Frequency*	0.3 GHz	0.6 GHz	0.9 GHz	1.2 GHz	1.5 GHz	1.8 GHz	2.1 GHz	2.4 GHz	2.7 GHz	3.0 GHz
Attenuation*	5.0 dB	7.7 dB	9.9 dB	11.6 dB	13.4 dB	15.3 dB	17.3 dB	19.3 dB	21 dB	22.5 dB
Recommended max frequency	3.0 GHz									
Insulation resistance	> 200 Mohm									
Contact resistance	< 0.01 ohm									
Wet matings	N/A (dry mating only)									
Temperature rating (water)	- 4 to 60°C, 25 to 140°F									
Temperature rating (air)	- 40 to 60°C, - 40 to 140°F									
Storage temperature rating	- 40 to 60°C, - 40 to 140°F									
Qualified pressure tested	600 bar, 8,700 psi									

Material specifications

Connector body	Chloroprene rubber
Bulkhead body	Brass, stainless steel, titanium or anodised aluminium
Coax contacts	Gold plated contacts
O-rings	Nitrile
Locking sleeves	POM or stainless steel
Snap rings	Stainless steel AISI 302
Inline cable (2 ft, 60 cm)	PUR jacket cable with RG58 coax
Coax bulkhead leads (3.3 ft, 100 cm)	RG316 coax

Face view (male)



Nominal cable outside diameter (OD)

RG58 PUR cable 0.220", 5.59 mm

Additional information

*All frequency and attenuation values are based on a 10 meter cable assembly test including 2 bulkhead connectors (50 ohm).
BNC connector for RG316 coax leads use Amphenol 031-315-RFX or equivalent.
BNC connector for RG58 coax cable use Amphenol 112116 or equivalent.

Recommended SMB termination for Coax, see pages 128-129

SubConn® Coax connectors are designed for dry mating only. The Coax series is not suitable for open-face pressure or waterblock applications. Locking sleeves are required. Avoid greasing the actual coax part. The minimum bending radius for inline cables is 100 mm.

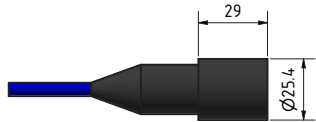

HF50CXILF

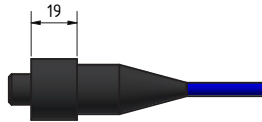

HF50CXILM

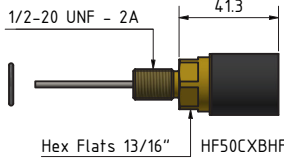
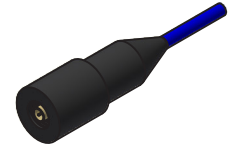

HF50CXBHF

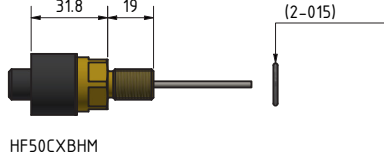

HF50CXBHM

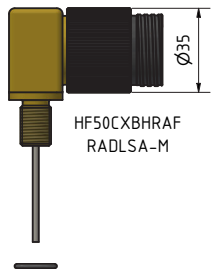
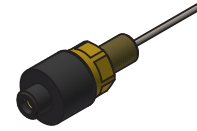

HF50CXBHRAF
RADLSA-M

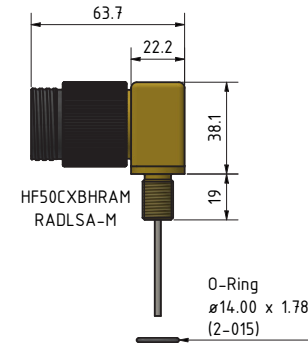

HF50CXBHRAM
RADLSA-M

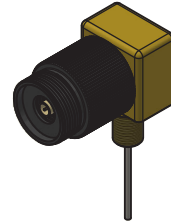

Note:
RA body are not available
in PEEK.
RADLSA-M locking sleeve
in colour black only
(female version not available)

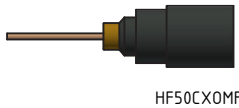

HF50CX0MF

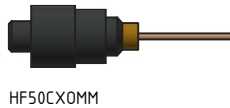

HF50CX0MM

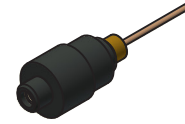

HF50CXDCF



HF50CXDCM

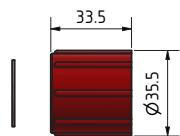

DLSA-F

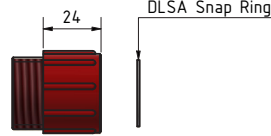

DLSA-M



Drawing information

Dimensions in mm (1 mm = 0.03937 inch)
Threads in inches (1 inch = 25.4 mm)